

East Coast Feathered Horse Show

June 9-11, 2023

Pattern Book

Halter Classes

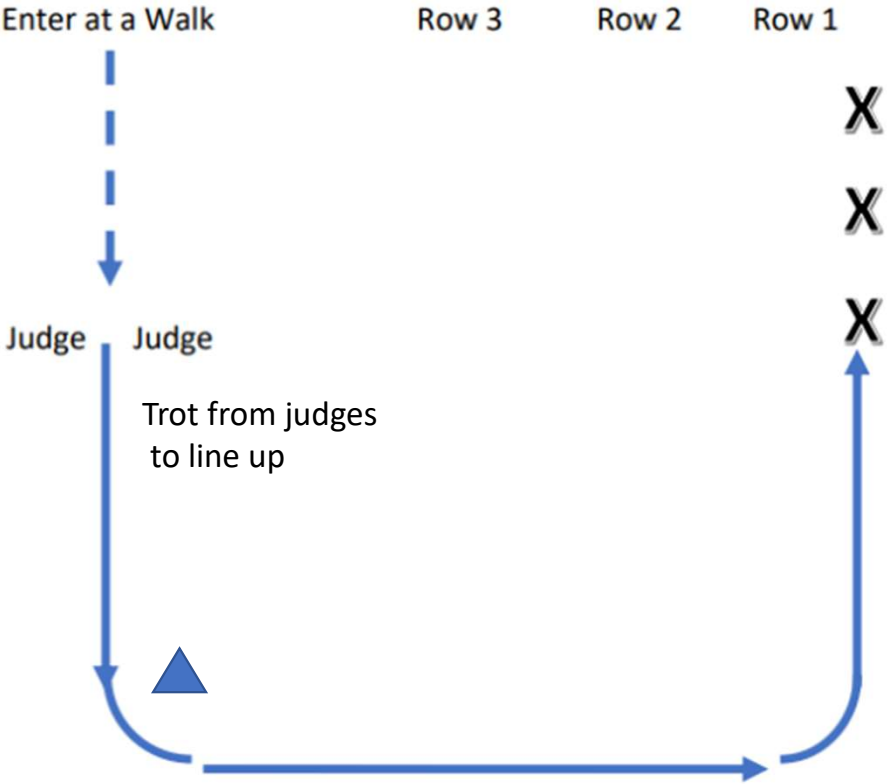

Dressage Suitability in Hand

1. Handlers will line horse up at A for inspection.
2. When dismissed, walk small triangle.
3. Trot the large triangle.
4. Set horse up at A until dismissed.

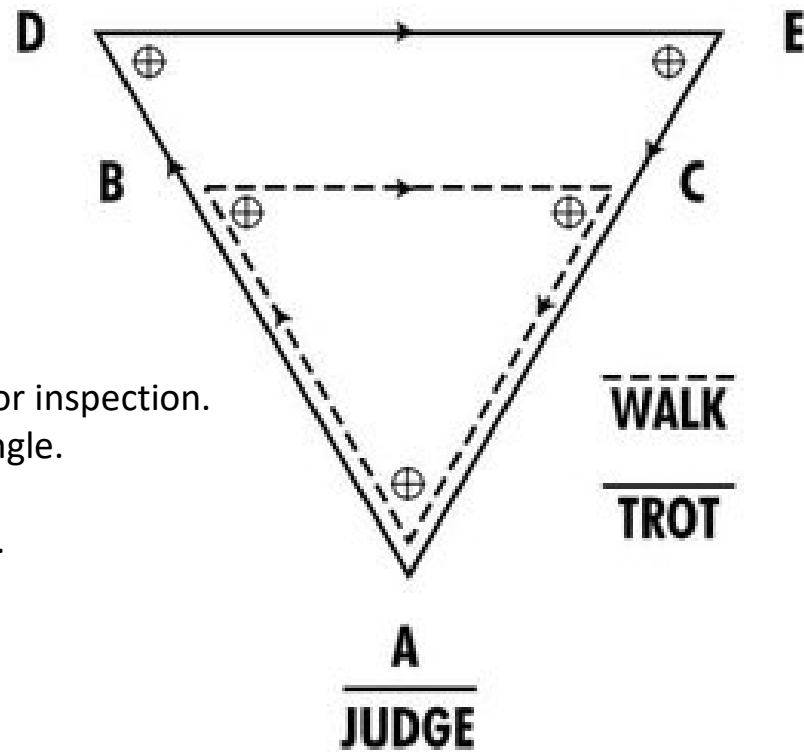

Showmanship

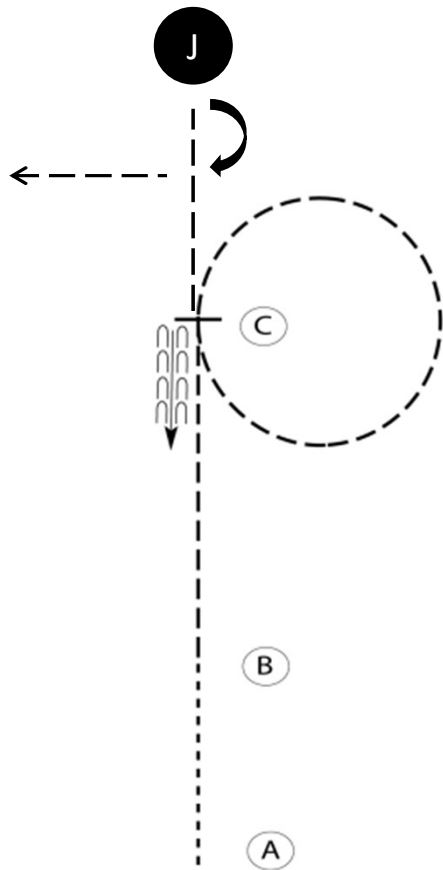

Be ready at A.

1. Walk to B.
2. Trot to C and continue trotting circle.
3. Stop at C and back 4 steps.
4. Walk to judge and set up for inspection.
5. When dismissed, turn 270° and walk to exit.

Take directions from ring steward.

W/T Equitation

(Youth & Adult)

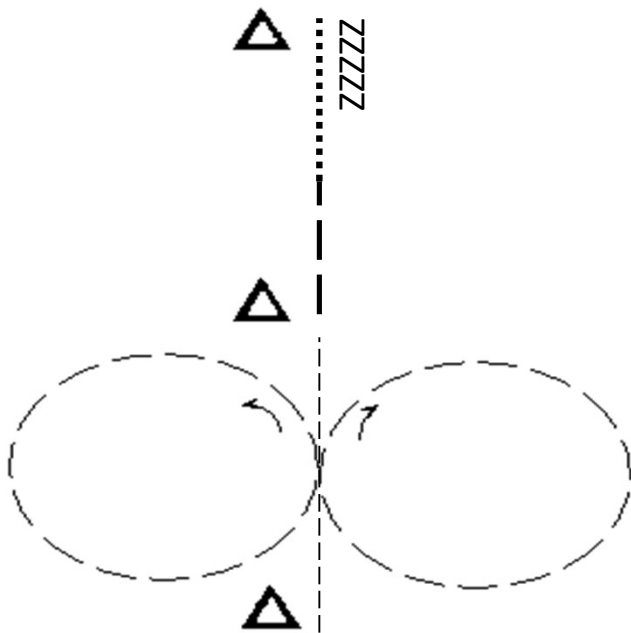

Be ready at cone A.

1. Trot & perform figure 8 starting either direction
2. At B, sitting trot halfway to C
3. Walk halfway to C.
4. Stop at C & back one-horse length.
Drop/lengthen reins to signify completion.
Exit at walk.

W/T/C Equitation

(Youth & Adult)

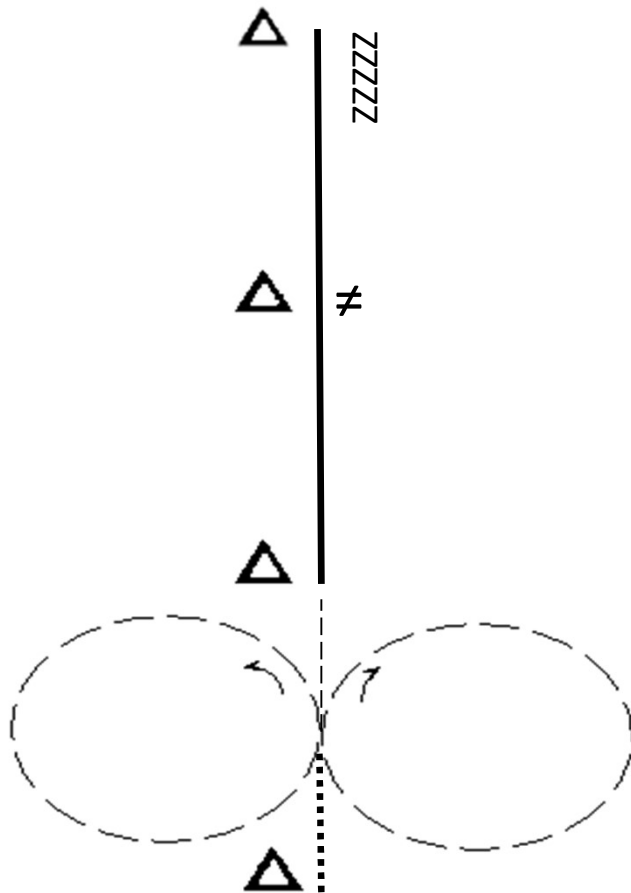

Be ready at cone A.

1. Walk halfway to B.
2. Trot a figure 8 starting either direction
3. At B, canter right lead to C.
4. At C perform a lead change.
5. Canter to D.
6. Stop at D and back one-horse length.

Exit at trot.

Trail in Hand & W/T Trail

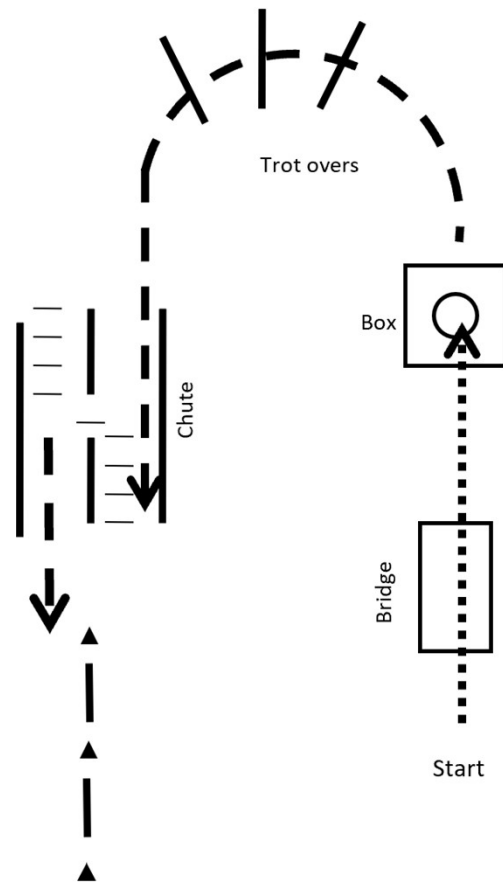

1. Walk to and over the bridge.
2. Walk to and into the box. Turn 360° to the right.
3. Walk out of box & trot to and over the logs.
4. Continue trotting into the chute and stop.
5. Back through the middle of the chute and to the end of the other side.
6. Trot out of the chute to the serpentine.
7. Trot through serpentine starting on the right side and to exit.

(Pattern complete when exhibitor passes last cone)

Trail W/T/C

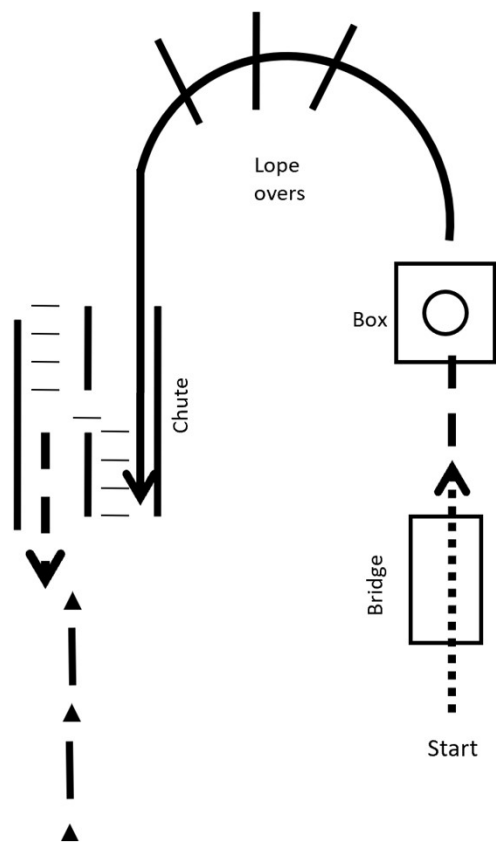

1. Walk to and over the bridge.
 2. Trot to and into the box. Turn 360° to the left.
 3. Walk out of box & lope left lead to and over the logs.
 4. Continue loping into the chute and stop.
 5. Back through the middle of the chute and to the end of the other side.
 6. Trot out of the chute and through the serpentine starting on the right side to the exit.
- (Pattern is complete when exhibitor passes last cone)

W/J Horsemanship

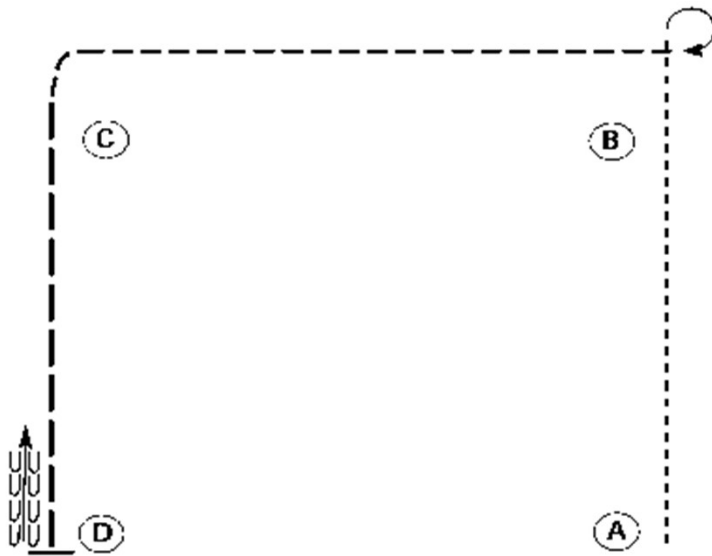

Be ready at A.

1. Walk from A to B.
2. Stop past B & execute a 270 degree turn to the right.
3. Jog from B around C.
4. Extend the jog from C to D.
5. Stop at D & back one horse length.

Please exit at a jog.

W/J/L Horsemanship

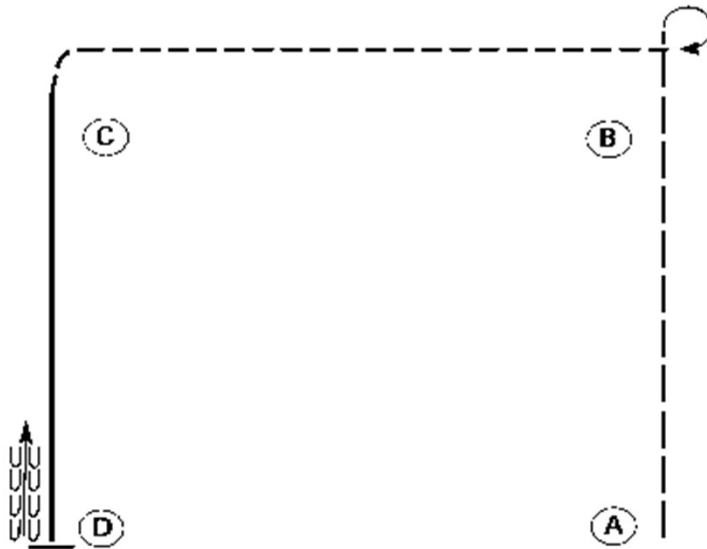

Be ready at A.

1. Extended jog from A to B.
2. Stop past B & execute a 270 degree turn to the right.
3. Jog from B around C.
4. Lope on the left lead from C to D.
5. Stop at D & back one horse length.

Please exit at a jog.

W/T Ranch Riding

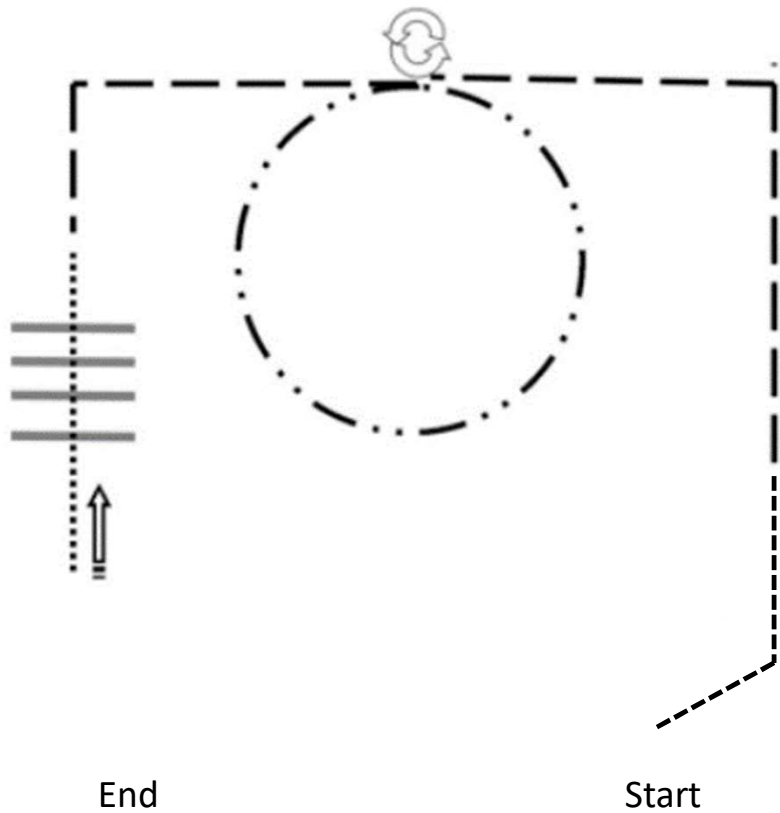

1. Walk
2. Trot
3. Extended trot circle left
4. Stop and turn 360° either direction.
5. Trot
6. Walk
7. Walk over poles
8. Stop and back

W/T/C Ranch Riding

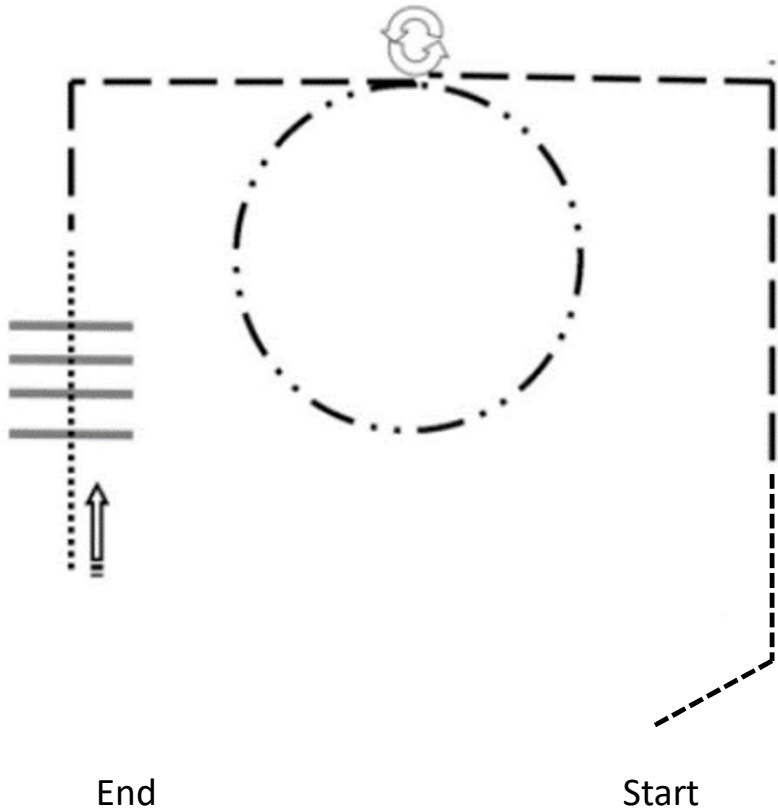

1. Walk
2. Trot
3. Lope circle left lead
4. Stop and turn 360° either direction.
5. Extended trot.
6. Walk
7. Walk over poles
8. Stop and back



www.buckeyeequestrianevents.com

Class counts, results & score sheets will be posted
online at: horseshowing.com